

M12 male 0° / M12 male 0° D-cod. shielded

TPE 22AWG SF/UTP CAT5e gn UL/CSA. ITC/PLTC 35m

USA

Ethernet CAT5

The resistance to aggressive media should be individually tested for your application. Further details on request.

Male straight – male straight

M12 – M12, 4-pole

D-coded

shielded

without cable sleeves

Further cable lengths on request.

Plastic housings with good resistance against chemicals and oils.

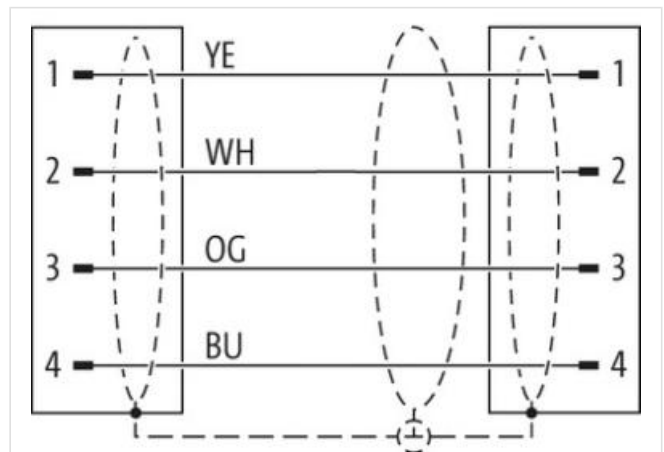
[Link to Product](#)**Illustration**

Product may differ from Image

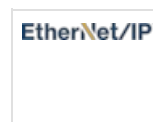

Cable length 35 m

Side 1

Tightening torque	0,6 Nm
Mounting method	inserted, screwed
Family construction form	M12
Thread	M12 x 1
Cable outlet	straight
Coding	D
No. of poles	4
Width across flats	SW13

Side 2

Tightening torque	0,6 Nm
Mounting method	inserted, screwed
Family construction form	M12
Thread	M12 x 1
Cable outlet	straight
Coding	D
No. of poles	4
Width across flats	SW13

Commercial data

ECLASS-6.0	27061801
ECLASS-6.1	27060307
ECLASS-7.0	27060307
ECLASS-8.0	27060307
ECLASS-9.0	27060307
ECLASS-10.1	27060307
ECLASS-11.1	27060307
ECLASS-12.0	27060307
ETIM-5.0	EC002599
customs tariff number	85444290
GTIN	4048879700955
Packaging unit	1

Electrical data | Supply

Operating voltage DC max.	60 V
Current operating per contact (UL)	1,5 A
Current operating per contact max.	1,5 A

Industrial communication

Transfer parameters	CAT5, Class D (ISO/IEC 11801:2002), (EN 50173-1)
Data transmission rate max.	100 MBit/s

Industrial communication | Ethernet functionality

duplex	Full duplex
--------	-------------

Diagnostics

Status indication LED	no
-----------------------	----

Installation | Connection

Gender	male
--------	------

Device protection | Electrical

Degree of protection (EN IEC 60529)	IP65, IP67, IP66K
Additional condition protection degree	inserted, screwed
Pollution Degree	3
Rated surge voltage	1,5 kV
Material group (IEC 60664-1)	I

Mechanical data	
Contour for corrugated hose	without
Mechanical data Material data	
Coating locking	Nickeled
Color housing	black
Material housing	PUR
Locking material	Zinc die-casting
Mechanical data Mounting data	
Mounting method	inserted, screwed, Shaking protection
Environmental characteristics Climatic	
Operating temperature min.	-25 °C
Operating temperature max.	85 °C
Additional condition temperature range	depending on cable quality
Important installation notes	
Note on strain relief	Protect the connectors by suitable measures from mechanical loads, e.g. by the usage of cable ties.
Note on bending radius	Attention: Observe the permissible bending radii when laying cables, as the IP protection class can be endangered by excessive bending forces.
Conformity	
Product standard	DIN EN 61076-2-101 (M12)
Installation Cable	
wire arrangement	(white, blue), (orange, yellow)
Cable identification	S7V
Jacket Color	green
Type of Certificate	cURus
Amount stranding	2
Stranding	2 wires twisted
Amount stranding (type 2)	1
Stranding (type 2)	2 Stranded joints twisted
Cable shielding (type)	copper braid, tinned
Cable shielding (coverage)	75 %
Banding	Foil
wire arrangement	(white, blue), (orange, yellow)
Cable weight	74,8 g/m
Material jacket	TPE
Freedom from ingredients (jacket)	lead-free, CFC-free
Outer-diameter (jacket)	7,87 mm
Tolerance outer diameter (sheath)	± 5 %
Material wire insulation	HDPE
Amount wires	4
Outer diameter insulation	1,47 mm
Outer diameter tolerance core insulation	± 5 %
Ingredient freeness wire insulation	lead-free, CFC-free
Amount strands (wire)	19
Diameter of single wires	22 AWG
Conductor crosssection (wire)	22 AWG
Material conductor wire	copper stranded wire, tinned
Nominal voltage AC max.	600 V
Current load capacity (standard)	to DIN VDE 0298-4
Current load capacity min. wire	4,8 A
Electrical resistance line constant wire	45,1 Ω/km
Min. operating temperature (static)	-40 °C
Max. operating temperature (fixed)	80 °C

Operating temperature min. (dynamic)	-40 °C
Operating temperature max. (dynamic)	80 °C
Storage temperature min.	-40 °C
Storage temperature max.	80 °C
Flame resistance	IEC 60332-2-2 UL 1581 § 1100 FT2 UL 1581 § 1090
chemical resistance	Good, application-related testing
Gasoline resistance	Good, application-related testing
Oil resistance	Good, application-related testing DIN EN 60811-404
Bending radius (dynamic)	2 x Outer diameter
No. of bending cycles (C-track)	35 Mio.
No. of torsion cycles	5 Mio.
Torsion stress	± 180 °/m