

**M12 male 0° / M12 female 0° A-cod. F&B**

PVC 4x0.34 gy UL/CSA 14m

**F&B**

Male straight – female straight

M12 – M12, 4-pole

Profile gasket

Plastic housings with good resistance against chemicals and oils.

The resistance to aggressive media should be individually tested for your application. Further details on request.

Further cable lengths on request.

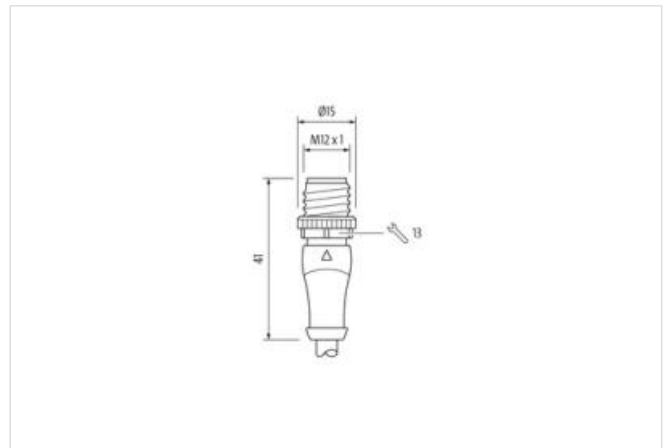
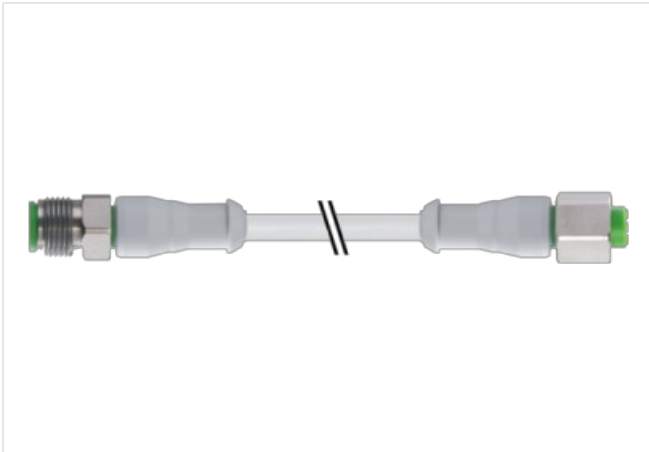
**[Link to Product](#)****Illustration**



Product may differ from Image



Cable length 14 m

**Side 1**

Tightening torque	0,6 Nm
Family construction form	M12
Thread	M12 x 1
Degree of protection (EN IEC 60529)	IP65, IP68

**Side 2**

Tightening torque	0,6 Nm
Family construction form	M12
Thread	M12 x 1
Degree of protection (EN IEC 60529)	IP65, IP68

**Commercial data**

ECLASS-6.0	27279218
ECLASS-6.1	27279218
ECLASS-7.0	27279218
ECLASS-8.0	27279218
ECLASS-9.0	27060311
ECLASS-10.1	27060311
ECLASS-11.1	27060311
ECLASS-12.0	27060311
ETIM-5.0	EC001855
customs tariff number	85444290
GTIN	4048879868488
Packaging unit	1

**Electrical data | Supply**

Operating voltage AC max.	250 V
Operating voltage DC max.	250 V
Current operating per contact max.	4 A

**Device protection | Electrical**

Additional condition protection degree	inserted, screwed
Pollution Degree	3

Rated surge voltage	2,5 kV
Material group (IEC 60664-1)	I
<b>Mechanical data   Material data</b>	
Locking material	Stainless steel 1.4404 (V4A)
<b>Mechanical data   Mounting data</b>	
Mounting method	inserted, screwed, Shaking protection
<b>Environmental characteristics   Climatic</b>	
Operating temperature min.	-25 °C
Operating temperature max.	85 °C
Additional condition temperature range	depending on cable quality
<b>Important installation notes</b>	
Note on strain relief	Protect the connectors by suitable measures from mechanical loads, e.g. by the usage of cable ties.
Note on bending radius	<b>Attention:</b> Observe the permissible bending radii when laying cables, as the IP protection class can be endangered by excessive bending forces.
<b>Installation   Cable</b>	
wire arrangement	brown, black, blue, white
Cable identification	214
Cable Type	1
Jacket Color	gray
Type of Certificate	cURus
Amount stranding	1
Stranding	4 wires twisted
wire arrangement	brown, black, blue, white
Cable weight	40,7 g/m
Material jacket	PVC
Shore hardness jacket	85 ± 5 Shore A
Freedom from ingredients (jacket)	lead-free, cadmium-free, CFC-free, silicone-free
Outer-diameter (jacket)	5 mm
Tolerance outer diameter (sheath)	± 5 %
Material wire insulation	PVC
Amount wires	4
Outer diameter insulation	1,25 mm
Outer diameter tolerance core insulation	± 5 %
Shore hardness wire insulation	45 ± 5 Shore D
Material properties wire insulation	good machinability
Ingredient freeness wire insulation	lead-free, cadmium-free, CFC-free, silicone-free
Amount strands (wire)	19
Diameter of single wires	0,15 mm
Conductor crosssection (wire)	0,34 mm <sup>2</sup>
Material conductor wire	Stranded copper wire, bare
Conductor type (wire)	Strand class 5
Nominal voltage AC max.	300 V
Current load capacity (standard)	to DIN VDE 0298-4
Current load capacity min. wire	4,8 A
Electrical resistance line constant wire	57 Ω/km @ 20 °C
AC withstand voltage (wire - wire)	2 kV @ 60 s
Power frequency withstand voltage (wire - jacket)	2 kV @ 60 s
Min. operating temperature (static)	-30 °C
Max. operating temperature (fixed)	80 °C
Operating temperature min. (dynamic)	-5 °C
Operating temperature max. (dynamic)	80 °C
Flame resistance	UL 1581 § 1100 FT2   IEC 60332-2-2   UL 1581 § 1090

chemical resistance	Good, application-related testing
Gasoline resistance	Good, application-related testing
Oil resistance	Good, application-related testing   DIN EN 60811-404
Bending radius (fixed)	5 x Outer diameter
Bending radius (dynamic)	10 x Outer diameter