

M23 FEMALE 0° 6POLE

PVC (4G1,5+(2x1,5)C)C 18m

Power cable with brake wires for SINAMICS S120 and motors with M23 connection and holding brake

Female straight

M23, 6-pole

without cable sleeves

Further cable lengths on request.

Plastic housings with good resistance against chemicals and oils.

The resistance to aggressive media should be individually tested for your application. Further details on request.

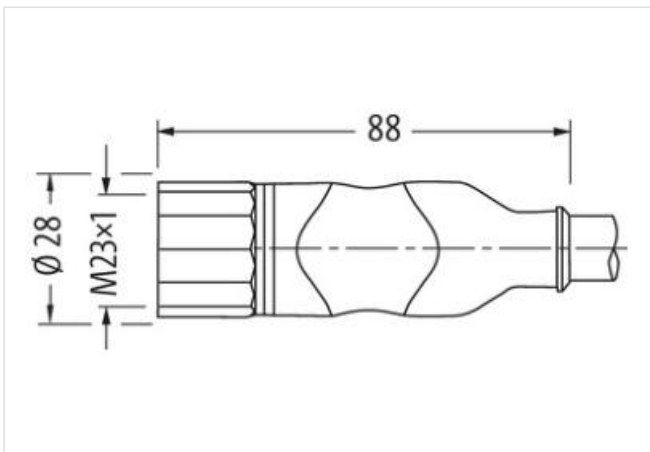
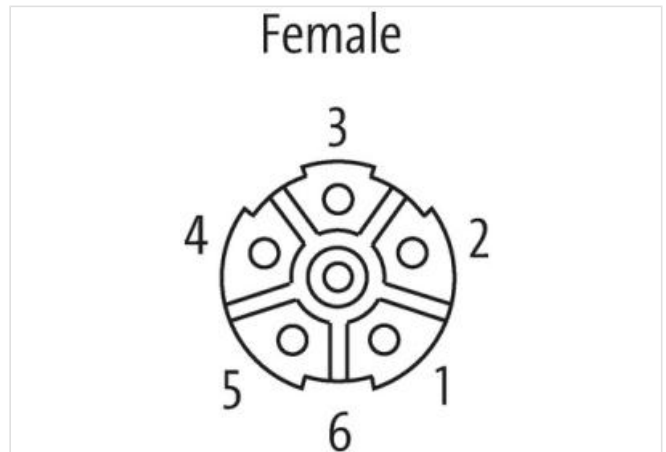
Power cores: 12 A (1.5 mm²), 15 A (2.5 mm²); brake cores: 5 A (1.5 mm²)[Link naar het product](#)**Afbeelding**

Product van afwijken van afbeelding

Cable length 18 m

Side 1

Tightening torque 2 Nm

Family construction form M23

Thread M23 x 1

suitable for corrugated tube (internal Ø) 16 mm

Width across flats SW27

Commerciële gegevens

ECLASS-6.0	27279218
ECLASS-6.1	27279218
ECLASS-7.0	27279218
ECLASS-8.0	27279218
ECLASS-9.0	27060327
ECLASS-10.1	27060311
ECLASS-11.1	27060311
ECLASS-12.0	27060327
ETIM-5.0	EC001855
Douane tarief nummer	85444290
GTIN	4048879837149
Verpakkingseenheid	1

Electrical data | Supply

Operating voltage AC per power contact max.	600 V
Operating voltage AC per signal contact max.	250 V
Operating voltage DC per power contact max.	600 V
Operating voltage DC per signal contact max.	250 V

Device protection | Electrical

Degree of protection (EN IEC 60529)	IP65, IP67
Additional condition protection degree	inserted, screwed
Pollution Degree	3
Rated surge voltage power contacts	4 kV
Rated surge voltage signal contacts	2 kV
Material group (IEC 60664-1)	I

Mechanical data | Material data

Coating locking	nickel plated
Material housing	PUR
Locking material	Brass

Mechanical data | Mounting data

Mounting method	inserted, screwed, Shaking protection
-----------------	---------------------------------------

Environmental characteristics | Climatic

Operating temperature min.	-25 °C
Operating temperature max.	85 °C
Additional condition temperature range	depending on cable quality

Important installation notes

Note on strain relief	Protect the connectors by suitable measures from mechanical loads, e.g. by the usage of cable ties.
Note on bending radius	Attention: Observe the permissible bending radii when laying cables, as the IP protection class can be endangered by excessive bending forces.

Installation | Cable

wire arrangement	black, white, (black W/L3/D/L-, black U/L1/C/L+, black V/L2, green-yellow)
Cable identification	861
Function cable	Hybrid, Signal, Power
Jacket Color	orange
Type of Certificate	cURus
Amount stranding	1
Stranding	2 wires with Filler twisted
Amount stranding (type 2)	1
Stranding (type 2)	4 wires with Filler around Stranding combination twisted
Cable shielding (type)	copper braid, tinned

Cable shielding (coverage)	85 %
Pair shielding (type)	copper braid, tinned
Banding	Fiber tape, Fleece, Foil
Filler	yes
wire arrangement	black, white, (black W/L3/D/L-, black U/L1/C/L+, black V/L2, green-yellow)
Cable weight	203,5 g/m
Material jacket	PVC
Freedom from ingredients (jacket)	lead-free, CFC-free, silicone-free
Outer-diameter (jacket)	10,4 mm
Tolerance outer diameter (sheath)	± 5 %
Material wire insulation	TPM
Amount wires	2
Outer diameter insulation	2,4 mm
Outer diameter tolerance core insulation	± 5 %
Ingredient freeness wire insulation	lead-free, CFC-free, silicone-free
Amount strands (wire)	30
Diameter of single wires	0,25 mm
Conductor crosssection (wire)	1,5 mm ²
Material conductor wire	Stranded copper wire, bare
Conductor type (wire)	Strand class 5
Outer diameter wire insulation (Power)	2,4 mm
Tolerance outer diameter wire insulation (Power)	±5 %
Ingredient freeness wire insulation (Power)	lead-free, CFC-free, silicone-free
Printing colour wire insulation (Power)	white (isolation black)
Amount wires (Power)	4
Amount strands wire (Power)	30
Diameter of single wires (Power)	0,25 mm
Wire conductor cross section (Power)	1,5 mm ²
Material conductor wire (Power)	Stranded copper wire, bare
Conductor type wire (Power)	Strand class 5
Max. rated voltage (conductor - conductor)	1000 V
Max. rated voltage (conductor - ground)	600 V
Current load capacity (standard)	to DIN VDE 0298-4
Current load capacity min. wire	12,6 A
Current carrying capacity min. wire (Power)	12,6 A
Electrical resistance line constant wire	13,7 Ω/km @ 20 °C
Electrical resistance coating wire (Power)	13,7 Ω/km @20 °C
AC withstand voltage (wire - wire)	2 kV @ 60 s
Electrical capacity line constant (wire - wire)	100000 pF/km
Electrical capacity line constant (wire - shield)	160000 pF/km
Power frequency withstand voltage (wire - jacket)	2 kV @ 60 s
AC withstand voltage (wire - shield)	2 kV @ 60 s
Isolation resistance	5000 MΩ × km
Electrical capacity line constant (wire - shield) (power)	250000 pF/km
Electrical capacity line constant (wire - wire) (power)	150000 pF/km
AC withstand voltage power (wire - shield)	4 kV @ 60 s
Power frequency withstand voltage power (wire - jacket)	4 kV @ 60 s
AC withstand voltage power (wire - wire)	4 kV @ 60 s
Min. operating temperature (static)	-25 °C
Max. operating temperature (fixed)	80 °C
Operating temperature min. (dynamic)	-5 °C

Operating temperature max. (dynamic)	60 °C
Flame resistance	UL 1581 § 1090 UL 1581 § 1100 FT2 IEC 60332-2-2
chemical resistance	Good, application-related testing
Gasoline resistance	Good, application-related testing
Oil resistance	DIN EN 60811-404 Good, application-related testing
Bending radius (fixed)	5 x Outer diameter
Bending radius (dynamic)	18 x Outer diameter
No. of bending cycles (C-track)	0,1 Mio. @ 25 °C
Traversing distance (C-track)	5 m @ 25 °C
Travel speed (C-track)	0,5 m/s @ 25 °C
Torsion stress	± 30 °/m