

M12 male 0° / M12 female 90° B-cod. shielded

PUR 1x2xAWG24 shielded vt UL/CSA+drag ch. 0.6m

PROFIBUS

Male straight – female 90°

M12 – M12, 2-pole

B-coded

shielded

Plastic housings with good resistance against chemicals and oils.

The resistance to aggressive media should be individually tested for your application. Further details on request.

Further cable lengths on request.

[Link to Product](#)

Illustration

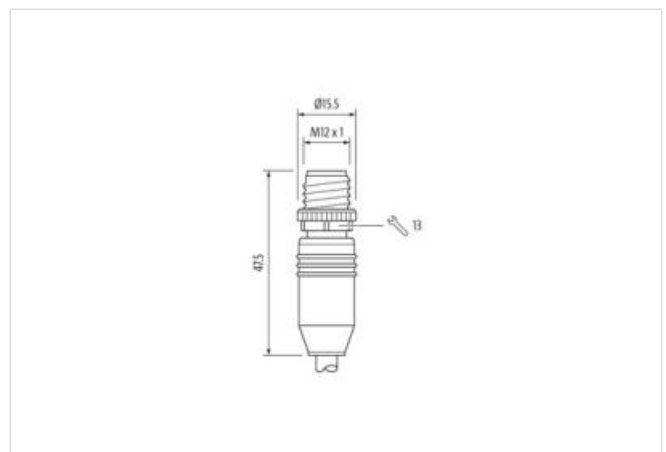
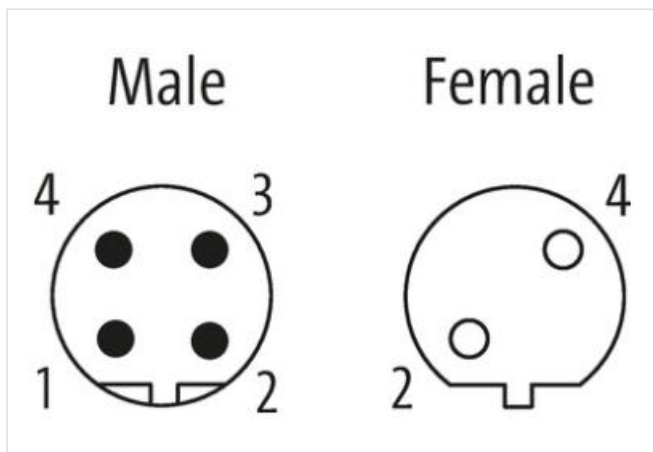



Product may differ from Image



Cable length 0,6 m

Side 1

Tightening torque	0,6 Nm
Thread	M12 x 1
Degree of protection (EN IEC 60529)	IP67

Side 2

Tightening torque	0,6 Nm
Thread	M12 x 1

Commercial data

ECLASS-6.0	27061801
ECLASS-6.1	27060307
ECLASS-7.0	27060307
ECLASS-8.0	27060307
ECLASS-9.0	27060307
ECLASS-10.1	27060307
ECLASS-11.1	27060307
ECLASS-12.0	27060307
ETIM-5.0	EC001855
customs tariff number	85444290
GTIN	4048879339582
Packaging unit	1

Electrical data | Supply

Operating voltage AC max.	60 V
Operating voltage DC max.	60 V
Operating voltage AC (UL-listed)	30 V
Operating voltage DC (UL-listed)	30 V
Current operating per contact max.	4 A

Device protection | Electrical

Degree of protection (ISO 20653:2013)	IP66K
Additional condition protection degree	inserted, screwed
Rated surge voltage	1,5 kV

Mechanical data | Material data

The information in this Product-PDF has been compiled with the utmost care.

Liability for the correctness completeness and topicality of the information is restricted to gross negligence. Version: 2024-06-25

Murrelektronik B.V. | Takkebijsters 3 | 4817 BL Breda | Fon 085-22 20 282 | Fax 085-22 20 283 | shop@murrelektronik.nl | shop.murrelektronik.nl

Coating locking	Nickeled
Locking material	Zinc die-casting
Mechanical data Mounting data	
Mounting method	inserted, screwed, Shaking protection
Important installation notes	
Note on strain relief	Protect the connectors by suitable measures from mechanical loads, e.g. by the usage of cable ties.
Note on bending radius	Attention: Observe the permissible bending radii when laying cables, as the IP protection class can be endangered by excessive bending forces.
Installation Cable	
wire arrangement	red, green
Cable identification	840
Jacket Color	violet
Type of Certificate	cURus
Amount stranding	1
Stranding	2 wires twisted
Cable shielding (type)	copper braid, tinned
Cable shielding (coverage)	70 %
Banding	Fleece, Foil
wire arrangement	red, green
Cable weight	82,5 g/m
Material jacket	TPE-V
Freedom from ingredients (jacket)	lead-free, cadmium-free, CFC-free, halogen-free, silicone-free
Outer-diameter (jacket)	7,8 mm
Tolerance outer diameter (sheath)	± 5 %
Material inner jacket	TPE-V
Color (inner jacket)	white
Amount wires	2
Outer diameter insulation	2,55 mm
Outer diameter tolerance core insulation	± 5 %
Ingredient freeness wire insulation	lead-free, CFC-free, halogen-free
Amount strands (wire)	19
Diameter of single wires	24 AWG
Conductor crosssection (wire)	24 AWG
Material conductor wire	Stranded copper wire, bare
Nominal voltage AC max.	250 V
Current load capacity (standard)	to DIN VDE 0298-4
Current load capacity min. wire	3 A
Electrical resistance line constant wire	78 Ω/km @ 20 °C
AC withstand voltage (wire - wire)	1 kV @ 60 s
Electrical capacity line constant (wire - wire)	30000 pF/km
Power frequency withstand voltage (wire - jacket)	1 kV @ 60 s
AC withstand voltage (wire - shield)	1 kV @ 60 s
Min. operating temperature (static)	-40 °C
Max. operating temperature (fixed)	80 °C
Operating temperature min. (dynamic)	-20 °C
Operating temperature max. (dynamic)	70 °C
Flame resistance	UL 1581 § 1100 FT2 IEC 60332-2-2 UL 1581 § 1090
chemical resistance	Good, application-related testing
Gasoline resistance	Good, application-related testing
Oil resistance	Good, application-related testing DIN EN 60811-404
Bending radius (fixed)	10 x Outer diameter
Bending radius (dynamic)	12 x Outer diameter
No. of bending cycles (C-track)	5 Mio. @ 25 °C

The information in this Product-PDF has been compiled with the utmost care.

Liability for the correctness completeness and topicality of the information is restricted to gross negligence. Version: 2024-06-25

Murrelektronik B.V. | Takkebijsters 3 | 4817 BL Breda | Fon 085-22 20 282 | Fax 085-22 20 283 | shop@murrelektronik.nl | shop.murrelektronik.nl

Traversing distance (C-track)	5 m @ 25 °C horizontal
Travel speed (C-track)	3 m/s @ 25 °C
