

**M12 male 0° / M8 female 0° A-cod.**

PVC 4x0.25 bk UL/CSA 12m

Male straight – female straight

M12 – M8, 4-pole

Art-No. 7005 - M12/M8 Lite - (plastic hexagonal screw) on request with cable sleeves

Plastic housings with good resistance against chemicals and oils.

The resistance to aggressive media should be individually tested for your application. Further details on request.

Further cable lengths on request.

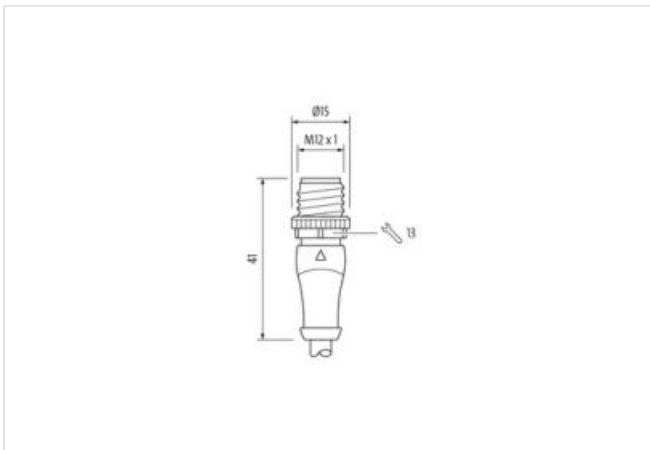
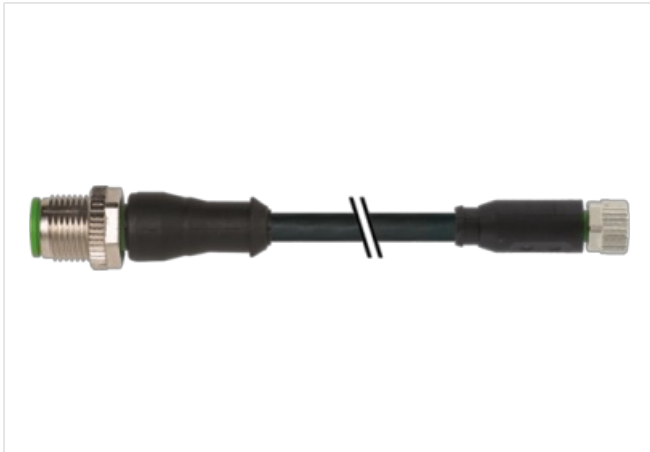
[Link to Product](#)**Illustration**



Product may differ from Image



Cable length 12 m

**Side 1**

Tightening torque	0,6 Nm
Mounting method	inserted, screwed
Family construction form	M12
Thread	M12 x 1
suitable for corrugated tube (internal Ø)	10 mm
Gender	male
Cable outlet	straight
Coding	A
Material contact	Copper alloy
Material	PUR
No. of poles	4
Width across flats	SW13
Degree of protection (EN IEC 60529)	IP65, IP66K, IP67

**Side 2**

Tightening torque	0,4 Nm
Mounting method	inserted, screwed
Family construction form	M8
Thread	M8 x 1
Gender	female
suitable for corrugated tube (internal Ø)	6,5 mm
Cable outlet	straight
Coding	A
Material contact	Copper alloy
Material	PUR
No. of poles	4
Width across flats	SW9
Degree of protection (EN IEC 60529)	IP65, IP66K, IP67

**Commercial data**

ECLASS-6.0	27279218
ECLASS-7.0	27279218
ECLASS-8.0	27279218

ECLASS-9.0	27060311
ECLASS-10.1	27060311
ECLASS-11.1	27060311
ECLASS-12.0	27060311
ETIM-5.0	EC001855
customs tariff number	85444290
GTIN	4048879363969
Packaging unit	1

**Electrical data | Supply**

Operating voltage AC max.	50 V
Operating voltage DC max.	60 V
Operating voltage AC (UL-listed)	30 V
Operating voltage DC (UL-listed)	30 V
Current operating per contact max.	4 A

**Diagnostics**

Status indication LED	no
-----------------------	----

**Device protection | Electrical**

Additional condition protection degree	inserted, screwed
Pollution Degree	3
Rated surge voltage	1,5 kV
Material group (IEC 60664-1)	I

**Mechanical data | Material data**

Coating locking	Nickeled
Coating of fitting	nickel plated
Material gasket	FKM
Locking material	Zinc die-casting
Material screw connection	Zinc die-casting

**Mechanical data | Mounting data**

Mounting method	inserted, screwed, Shaking protection
-----------------	---------------------------------------

**Environmental characteristics | Climatic**

Operating temperature min.	-25 °C
Operating temperature max.	85 °C
Additional condition temperature range	depending on cable quality

**Important installation notes**

Note on strain relief	Protect the connectors by suitable measures from mechanical loads, e.g. by the usage of cable ties.
Note on bending radius	<b>Attention:</b> Observe the permissible bending radii when laying cables, as the IP protection class can be endangered by excessive bending forces.

**Conformity**

Product standard	DIN EN 61076-2-101 (M12), DIN EN 61076-2-104 (M8)
------------------	---

**Installation | Cable**

wire arrangement	brown, black, blue, white
Cable identification	611
Cable Type	1
Jacket Color	black
Type of Certificate	cURus
Amount stranding	1
Stranding	4 wires twisted
wire arrangement	brown, black, blue, white
Cable weight	34,76 g/m
Material jacket	PVC
Shore hardness jacket	85 ± 5 Shore A

Freedom from ingredients (jacket)	lead-free, cadmium-free, CFC-free, silicone-free
Outer-diameter (jacket)	4,8 mm
Tolerance outer diameter (sheath)	± 5 %
Material wire insulation	PVC
Amount wires	4
Outer diameter insulation	1,25 mm
Outer diameter tolerance core insulation	± 5 %
Shore hardness wire insulation	45 ± 5 Shore D
Material properties wire insulation	good machinability
Ingredient freeness wire insulation	lead-free, cadmium-free, CFC-free, silicone-free
Amount strands (wire)	14
Diameter of single wires	0,15 mm
Conductor crosssection (wire)	0,25 mm <sup>2</sup>
Material conductor wire	Stranded copper wire, bare
Conductor type (wire)	Strand class 5
Nominal voltage AC max.	300 V
Current load capacity (standard)	to DIN VDE 0298-4
Current load capacity min. wire	3,6 A
Electrical resistance line constant wire	79 Ω/km @ 20 °C
AC withstand voltage (wire - wire)	2 kV @ 60 s
Power frequency withstand voltage (wire - jacket)	2 kV @ 60 s
Min. operating temperature (static)	-30 °C
Max. operating temperature (fixed)	80 °C
Operating temperature min. (dynamic)	-5 °C
Operating temperature max. (dynamic)	80 °C
UV resistance	DIN EN ISO 4892-2 A
Flame resistance	IEC 60332-2-2   UL 1581 § 1090   UL 1581 § 1100 FT2
chemical resistance	Good, application-related testing
Gasoline resistance	Good, application-related testing
Oil resistance	DIN EN 60811-404   Good, application-related testing
Bending radius (fixed)	5 x Outer diameter
Bending radius (dynamic)	10 x Outer diameter