

M12 male 0° / M12 female 90° A-cod. shielded

PUR 5x0.34 shielded gy UL/CSA 0,6m

⚠ NOTICE ⚠**PRODUCT WILL BE DISCONTINUED BY MARCH 2023. PLEASE HAVE A LOOK AT THE ALTERNATIVE PRODUCTS.**

Male straight – female 90°

M12 – M12, 5-pole
shielded

Plastic housings with good resistance against chemicals and oils.

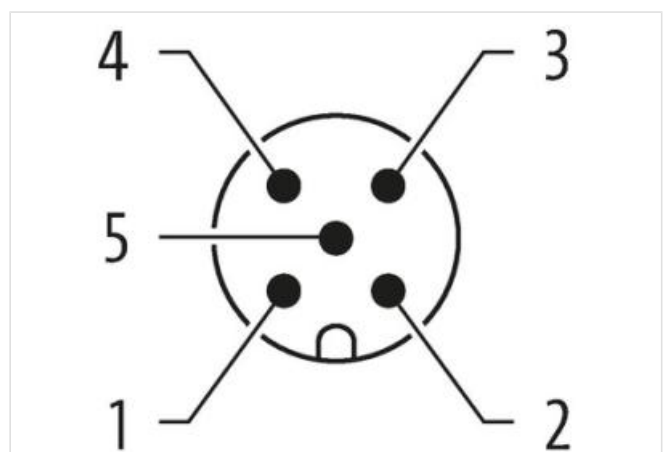
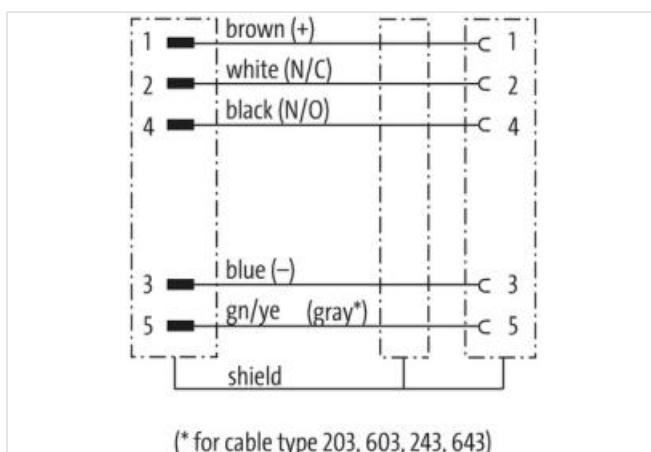
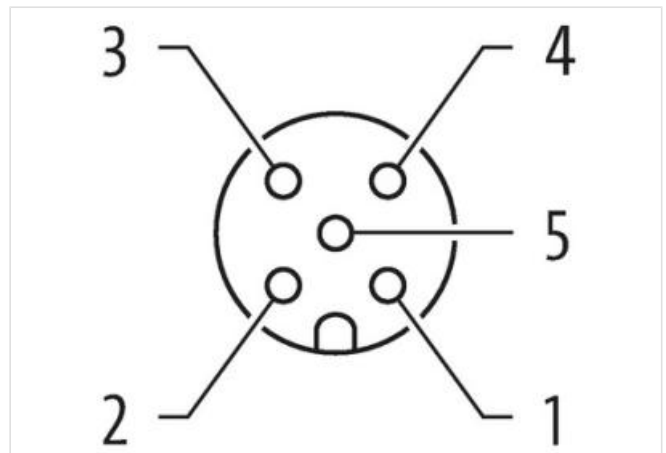
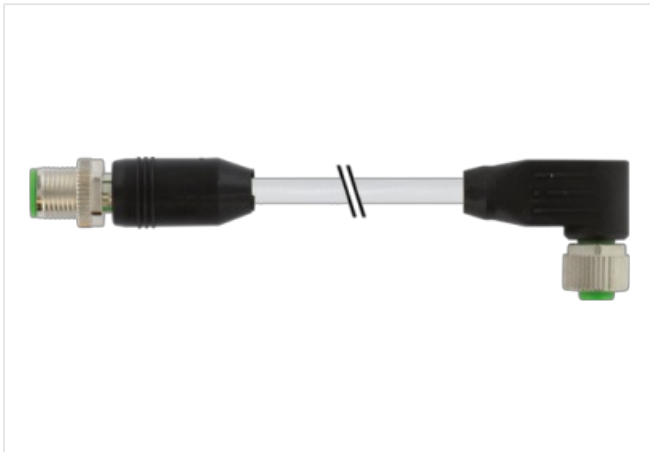
The resistance to aggressive media should be individually tested for your application. Further details on request.
Further cable lengths on request.[Link to Product](#)**Illustration**



Product may differ from Image



Cable length 0,6 m

Side 1

Tightening torque	0,6 Nm
Mounting method	inserted, screwed
Family construction form	M12
Thread	M12 x 1
Coding	A
Material	PUR
Width across flats	SW13
Degree of protection (EN IEC 60529)	IP65, IP67

Side 2

Tightening torque	0,6 Nm
Mounting method	inserted, screwed
Family construction form	M12
Thread	M12 x 1
Coding	A
Material	PUR
Width across flats	SW13

Commercial data

ECLASS-6.0	27279218
ECLASS-6.1	27279218
ECLASS-7.0	27279218
ECLASS-8.0	27279218
ECLASS-9.0	27060311
ECLASS-10.1	27060311
ECLASS-11.1	27060311
ECLASS-12.0	27060311
ETIM-5.0	EC001855
customs tariff number	85444290
GTIN	4048879376860
Packaging unit	1

Electrical data | Supply

Operating voltage AC max.	60 V
Operating voltage DC max.	60 V
Operating voltage AC (UL-listed)	30 V
Operating voltage DC (UL-listed)	30 V
Current operating per contact max.	4 A

Installation | Connection

Mounting set	M12 x 1
--------------	---------

Device protection | Electrical

Additional condition protection degree	inserted, screwed
Pollution Degree	3
Rated surge voltage	1,5 kV
Material group (IEC 60664-1)	I

Mechanical data

Contour for corrugated hose	without
-----------------------------	---------

Mechanical data | Material data

Coating locking	Nickeled
Coating of fitting	nickel plated
Material gasket	FKM
Locking material	Zinc die-casting
Material screw connection	Zinc die-casting

Mechanical data | Mounting data

Mounting method	inserted, screwed, Shaking protection
-----------------	---------------------------------------

Environmental characteristics | Climatic

Operating temperature min.	-25 °C
Operating temperature max.	85 °C
Additional condition temperature range	depending on cable quality

Installation | Cable

Cable identification	351
Jacket Color	gray
Amount stranding	1
Stranding	5 wires twisted
Cable shielding (type)	copper braiding, bare
wire arrangement	brown, white, blue, black, gray
Material jacket	PUR
Outer-diameter (jacket)	6,9 mm
Tolerance outer diameter (sheath)	± 5 %
Material wire insulation	PP
Amount wires	5
Conductor crosssection (wire)	0,34 mm ²
Current load capacity (standard)	to DIN VDE 0298-4
Min. operating temperature (static)	-40 °C
Max. operating temperature (fixed)	80 °C
Operating temperature min. (dynamic)	-20 °C
Operating temperature max. (dynamic)	80 °C
Flame resistance	UL 1581 § 1100 FT2 UL 1581 § 1090 IEC 60332-2-2
chemical resistance	Good, application-related testing
Gasoline resistance	Good, application-related testing
Oil resistance	Good, application-related testing DIN EN 60811-404
Bending radius (fixed)	10 x Outer diameter
Bending radius (dynamic)	15 x Outer diameter