

M12 male 90° A-cod. with cable

PUR 8x0.34 bk UL/CSA+drag ch. 10m

Male 90°

M12, 8-pole

Art-No. 7005 - M12 Lite - (plastic hexagonal screw) on request with cable sleeves

Plastic housings with good resistance against chemicals and oils.

The resistance to aggressive media should be individually tested for your application. Further details on request.

Further cable lengths on request.

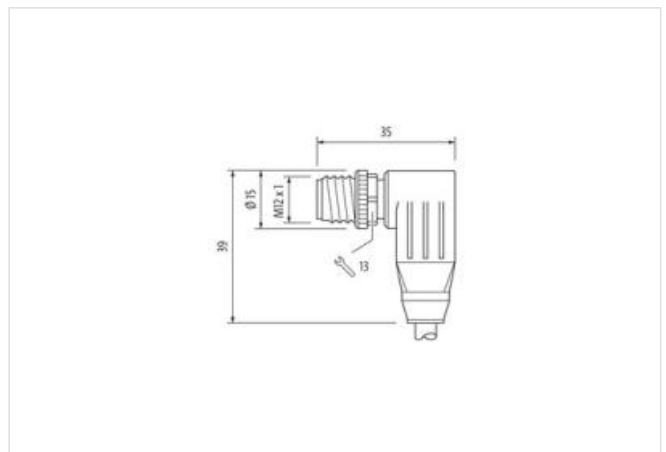
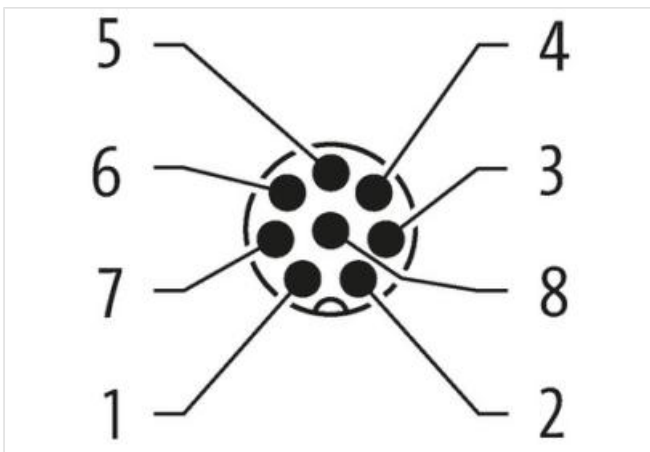
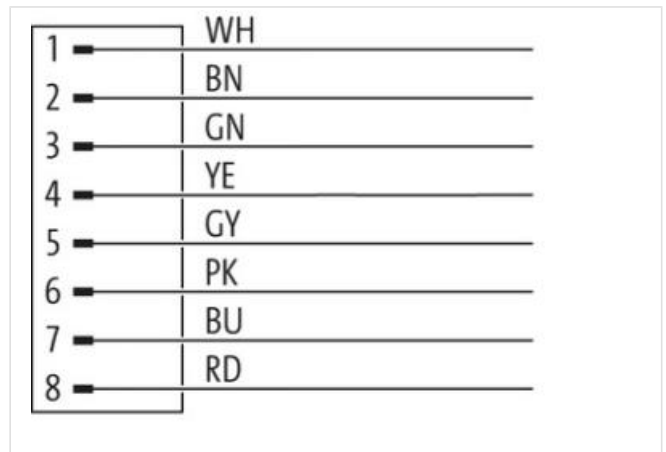
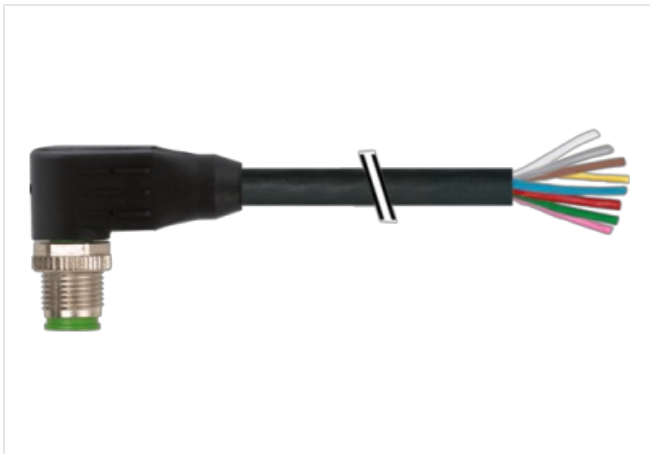
[Link naar het product](#)**Afbeelding**

Product van afwijken van afbeelding



Cable length 10 m

Side 1

Tightening torque 0,6 Nm

Mounting method	inserted, screwed
Family construction form	M12
Material	PUR
Width across flats	SW13
Commerciële gegevens	
ECLASS-6.0	27279218
ECLASS-7.0	27279218
ECLASS-8.0	27279218
ECLASS-9.0	27060311
ECLASS-10.1	27060311
ECLASS-11.1	27060311
ECLASS-12.0	27060311
ETIM-5.0	EC001855
Douane tarief nummer	85444290
GTIN	4048879637756
Verpakkingseenheid	1
Electrical data Supply	
Operating voltage AC max.	30 V
Operating voltage DC max.	30 V
Installation Connection	
Mounting set	M12 x 1
Device protection Electrical	
Pollution Degree	3
Rated surge voltage	0,8 kV
Material group (IEC 60664-1)	I
Mechanical data Material data	
Coating of fitting	nickel plated
Material screw connection	Zinc die-casting
Environmental characteristics Climatic	
Operating temperature min.	-25 °C
Operating temperature max.	85 °C
Additional condition temperature range	depending on cable quality
Important installation notes	
Note on strain relief	Protect the connectors by suitable measures from mechanical loads, e.g. by the usage of cable ties.
Note on bending radius	Attention: Observe the permissible bending radii when laying cables, as the IP protection class can be endangered by excessive bending forces.
Installation Cable	
wire arrangement	brown, white, red, blue, pink, gray, yellow, green
Cable identification	664
Cable Type	3
Jacket Color	black
Type of Certificate	cURus
Amount stranding	1
Stranding	8 wires around Core filler twisted
Filler	yes
wire arrangement	brown, white, red, blue, pink, gray, yellow, green
Cable weight	64,9 g/m
Material jacket	PUR
Shore hardness jacket	90 ± 5 Shore A
Freedom from ingredients (jacket)	lead-free, cadmium-free, CFC-free, halogen-free, silicone-free
Outer-diameter (jacket)	6,9 mm

Tolerance outer diameter (sheath)	± 5 %
Material wire insulation	PP
Amount wires	8
Outer diameter insulation	1,45 mm
Outer diameter tolerance core insulation	± 5 %
Shore hardness wire insulation	65 ± 5 Shore D
Ingredient freeness wire insulation	lead-free, cadmium-free, CFC-free, halogen-free, silicone-free
Amount strands (wire)	42
Diameter of single wires	0,1 mm
Conductor crosssection (wire)	0,34 mm ²
Material conductor wire	Stranded copper wire, bare
Conductor type (wire)	strand class 6
Nominal voltage AC max.	600 V
Current load capacity (standard)	to DIN VDE 0298-4
Current load capacity min. wire	4 A
Electrical resistance line constant wire	60 Ω/km @ 20 °C
AC withstand voltage (wire - wire)	6 kV @ 60 s
Power frequency withstand voltage (wire - jacket)	6 kV @ 60 s
Min. operating temperature (static)	-40 °C
Max. operating temperature (fixed)	90 °C
Operating temperature min. (dynamic)	-25 °C
Operating temperature max. (dynamic)	90 °C
UV resistance	DIN EN ISO 4892-2 A
Flame resistance	UL 1581 § 1100 FT2 UL 1581 § 1090 IEC 60332-2-2
chemical resistance	Good, application-related testing
Gasoline resistance	Good, application-related testing
Oil resistance	DIN EN 60811-404 Good, application-related testing
Bending radius (fixed)	5 x Outer diameter
Bending radius (dynamic)	10 x Outer diameter
No. of bending cycles (C-track)	5 Mio. @ 25 °C
Traversing distance (C-track)	5 m @ 25 °C horizontal
Travel speed (C-track)	3,3 m/s @ 25 °C
No. of torsion cycles	2 Mio.
Torsion stress	± 180 °/m
Torsion speed	35 cycles/min