

M8 female 0° SnapIn with cable

PUR 5x0.25 bk UL 10m

Female straight

Snap In

M8, 5-pole

B-coded

with cable sleeves

Plastic housings with good resistance against chemicals and oils.

The resistance to aggressive media should be individually tested for your application. Further details on request.

Further cable lengths on request.

[Link to Product](#)**Illustration**

1	BN
2	WH
3	BU
4	BK
5	GY

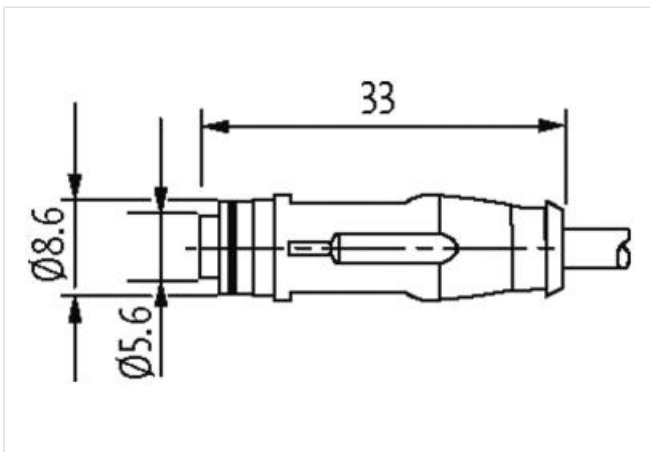

Product may differ from Image

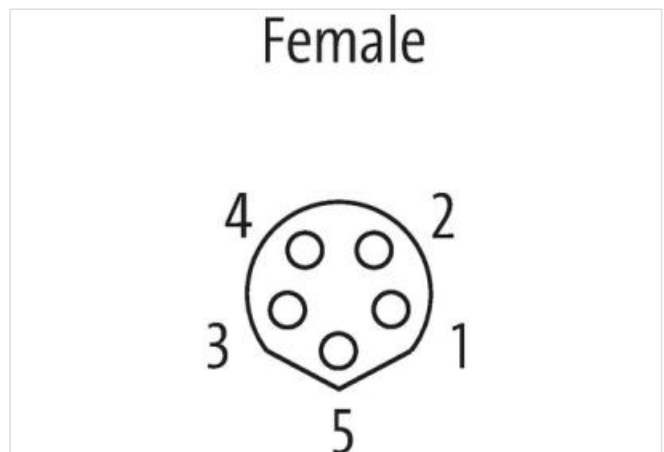

Cable length

10 m

Side 1

Mounting method	inserted
Family construction form	M8
Coding	B
Material contact	Copper alloy
Material	TPU
No. of poles	5
Degree of protection (EN IEC 60529)	IP67
Commercial data	
ECLASS-6.0	27279218
ECLASS-7.0	27279218
ECLASS-8.0	27279218
ECLASS-9.0	27060311
ECLASS-10.1	27060311
ECLASS-11.1	27060311
ECLASS-12.0	27060311
ETIM-5.0	EC001855
customs tariff number	85444290
GTIN	4048879779425
Packaging unit	1
Electrical data Supply	
Operating voltage AC max.	30 V
Operating voltage DC max.	30 V
Current operating per contact max.	3 A
Diagnostics	
Status indication LED	no
Installation Connection	
Mating cycles min.	100
Device protection Electrical	
Pollution Degree	3/2
Insulation resistance min.	100 MΩ
Mechanical data Material data	
Material screw connection	PUR
Mechanical data Mounting data	
Looking techniques	Snap In
Environmental characteristics Climatic	
Operating temperature min.	-30 °C
Operating temperature max.	80 °C
Additional condition temperature range	depending on cable quality
Important installation notes	
Note on strain relief	Protect the connectors by suitable measures from mechanical loads, e.g. by the usage of cable ties.
Note on bending radius	Attention: Observe the permissible bending radii when laying cables, as the IP protection class can be endangered by excessive bending forces.
Installation Cable	
wire arrangement	brown, white, black, blue, gray
Cable identification	695
Jacket Color	black
Amount stranding	1
Stranding	5 wires twisted
wire arrangement	brown, white, black, blue, gray
Material jacket	PUR

Outer-diameter (jacket)	4,7 mm
Tolerance outer diameter (sheath)	± 5 %
Material wire insulation	PP
Amount wires	5
Outer diameter insulation	1,2 mm
Outer diameter tolerance core insulation	± 5 %
Amount strands (wire)	32
Diameter of single wires	0,1 mm
Conductor crosssection (wire)	0,25 mm ²
Material conductor wire	Stranded copper wire, bare
Conductor type (wire)	strand class 6
Nominal voltage AC max.	300 V
Current load capacity (standard)	to DIN VDE 0298-4
Current load capacity min. wire	4,8 A
Electrical resistance line constant wire	58 Ω/km @ 20 °C
AC withstand voltage (wire - wire)	3 kV @ 60 s
Power frequency withstand voltage (wire - jacket)	3 kV @ 60 s
Min. operating temperature (static)	-25 °C
Max. operating temperature (fixed)	80 °C
Operating temperature min. (dynamic)	-10 °C
Operating temperature max. (dynamic)	80 °C
Flame resistance	UL 1581 § 1090 IEC 60332-2-2 UL 1581 § 1100 FT2
chemical resistance	Good, application-related testing
Gasoline resistance	Good, application-related testing
Oil resistance	DIN EN 60811-404 Good, application-related testing
Bending radius (dynamic)	7,5 x Outer diameter
No. of bending cycles (C-track)	5 Mio. @ 25 °C
Travel speed (C-track)	3 m/s